



PADMAWATI
EXTRUSION

CATALOGUE 2019

MISCELLANEOUS SECTIONS

Padmawati Extrusion Pvt. Ltd., with over 2 decades of experience, with focus on customer need and commitment to **quality, perfection and innovation**, has become one of the leading nationwide providers of aluminium.

The company has been engaged in the complete process of extrusion, from technical sales advise, designing, testing to providing all ancillary, hardware fittings for system windows, glazing systems, exhibition systems and various products and caters to architects, contractors and designers from different sectors & industries.

With an eye on quality, the company has also introduced **aluminium profiles with scratch free sand blasted anodize finish, brush anodize finish, mirror finish and various powder coated finishes** for our discerning customers.

Our way of working reflects delivering an advantage in every key aspect of our business – sourcing, operations and cost. Basically, we are a **one stop shop for extruded aluminium** custom solutions for practically any application.





MISCELLANEOUS SECTIONS

Section No 4011

Wt/Mtr 0.235 Kg

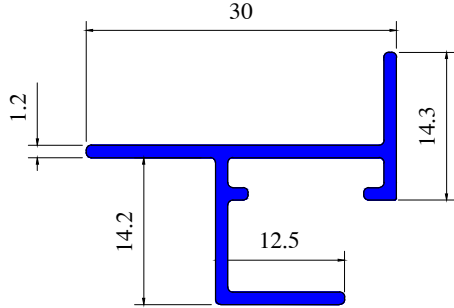

Section No 1148

Wt/Mtr 0.587 Kg

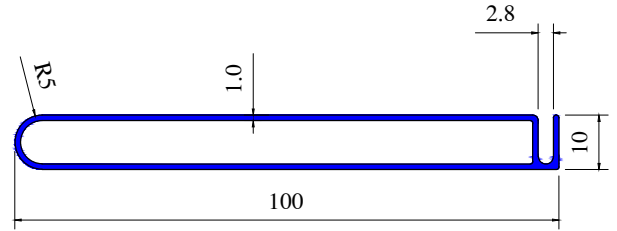

Section No 1194

Wt/Mtr 0.116 Kg

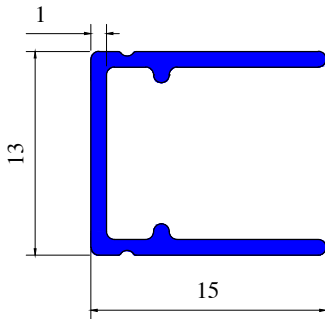

Section No 4323

Wt/Mtr 0.426 Kg

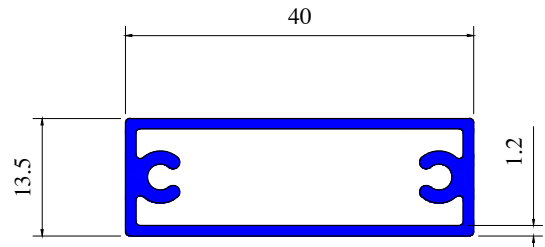

Section No 1545

Wt/Mtr 0.319 Kg

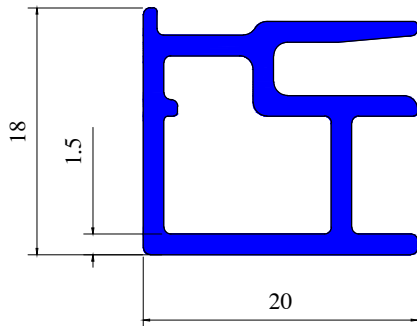

Section No 4024

Wt/Mtr 0.294 Kg

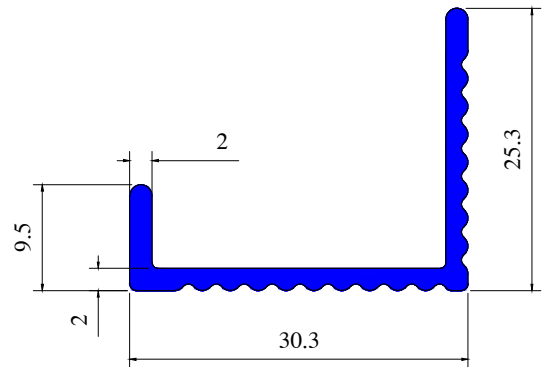

Section No 1180

Wt/Mtr 2.527 Kg

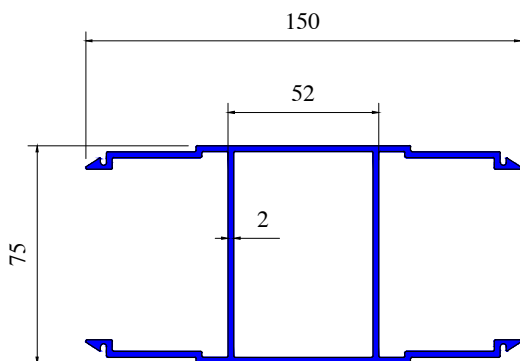

Section No 1181

Wt/Mtr 1.681 Kg

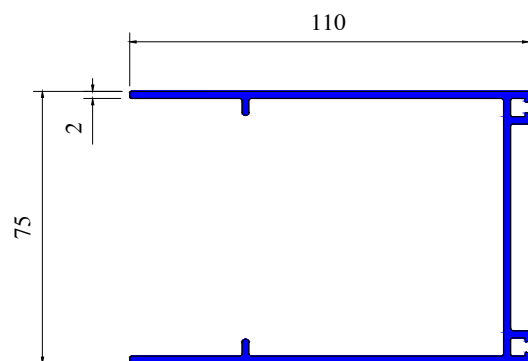



MISCELLANEOUS SECTIONS

Section No 4324

Wt/Mtr 0.584 Kg

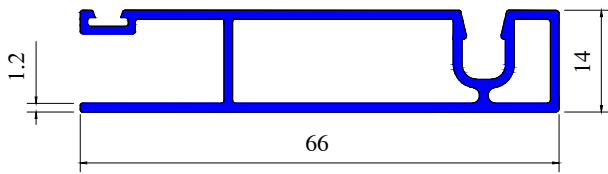

Section No 4321

Wt/Mtr 0.426 Kg

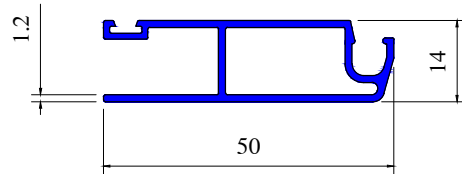

Section No 4314

Wt/Mtr 0.243 Kg

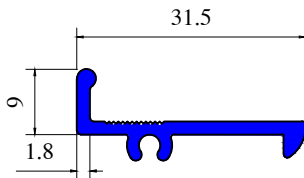

Section No 4322

Wt/Mtr 1.523 Kg

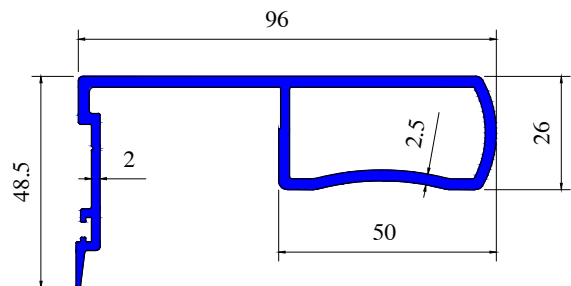

Section No 4315

Wt/Mtr 0.135 Kg

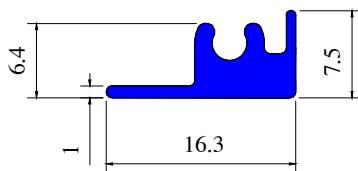

Section No 4025

Wt/Mtr 1.393 Kg

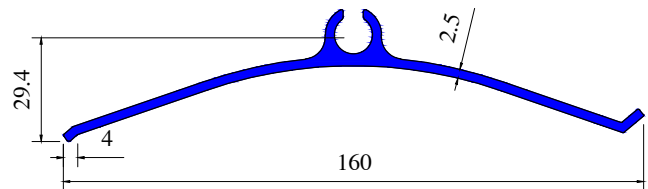

Section No 2603

Wt/Mtr 0.360 Kg

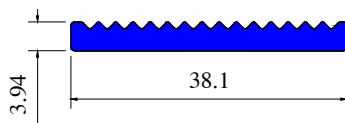

Section No 4316

Wt/Mtr 0.100 Kg

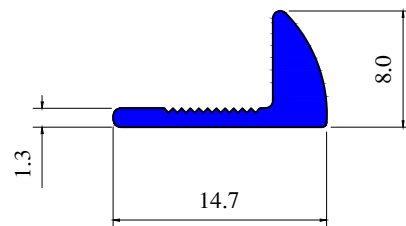

Section No 4005

Wt/Mtr 0.796 Kg

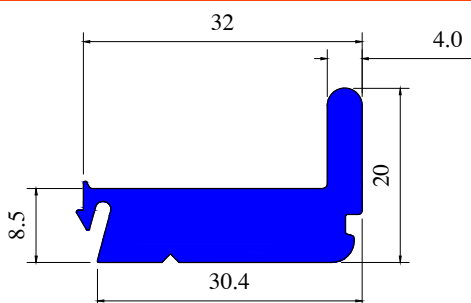

Section No 4006

Wt/Mtr 0.154 Kg

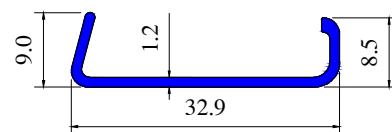



MISCELLANEOUS SECTIONS

Section No 1435

Wt/Mtr 1.012 Kg

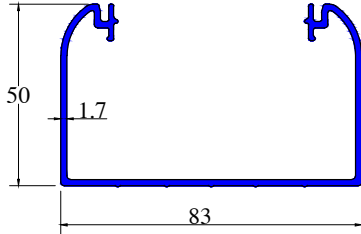

Section No 1436

Wt/Mtr 0.378 Kg

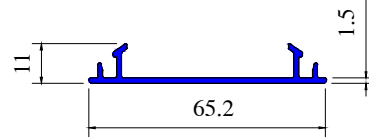

Section No 4350

Wt/Mtr 2.40 Kg

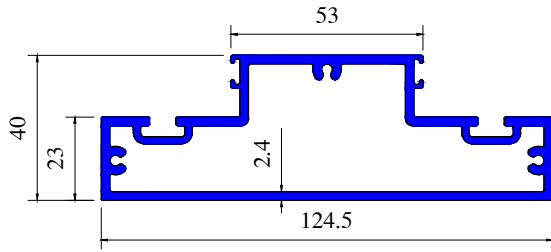

Section No 4028

Wt/Mtr 0.405 Kg

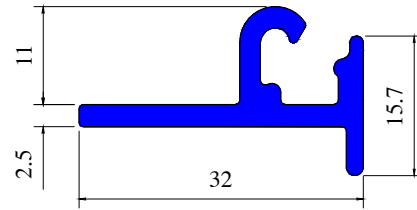

Section No 1511

Wt/Mtr 0.575 Kg

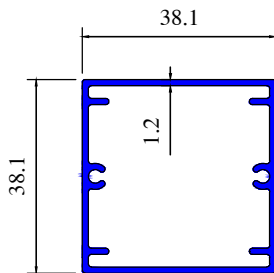

Section No 1146

Wt/Mtr 0.382 Kg

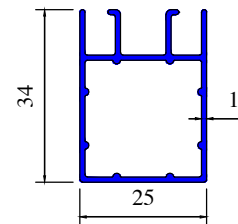

Section No 1512

Wt/Mtr 2.50 Kg

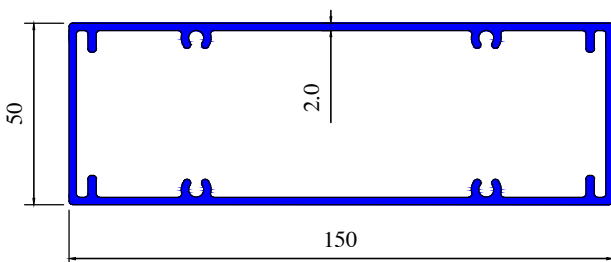

Section No 1147

Wt/Mtr 0.450 Kg

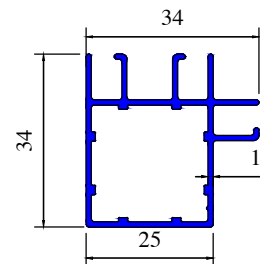



PADMAWATI EXTRUSION PVT. LTD.

5/2, Bharat Ashish Building, D.B. Gupta Road, Paharganj, New Delhi - 110055 (India)
+91 98999 07895, 98112 76191 | Email : info@padmawatiextrusion.com