



PADMAWATI
EXTRUSION

CATALOGUE 2019

CASEMENT WINDOW SECTIONS

Padmawati Extrusion Pvt. Ltd., with over 2 decades of experience, with focus on customer need and commitment to **quality, perfection and innovation**, has become one of the leading nationwide providers of aluminium.

The company has been engaged in the complete process of extrusion, from technical sales advise, designing, testing to providing all ancillary, hardware fittings for system windows, glazing systems, exhibition systems and various products and caters to architects, contractors and designers from different sectors & industries.

With an eye on quality, the company has also introduced **aluminium profiles with scratch free sand blasted anodize finish, brush anodize finish, mirror finish and various powder coated finishes** for our discerning customers.

Our way of working reflects delivering an advantage in every key aspect of our business – sourcing, operations and cost. Basically, we are a **one stop shop for extruded aluminium** custom solutions for practically any application.





CASEMENT WINDOW SECTIONS

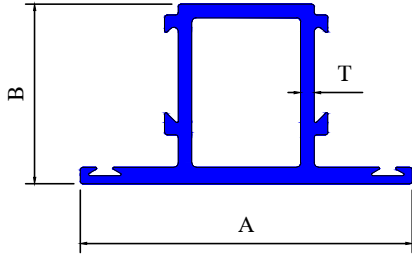

Section	A	B	T	Wt/Mtr
CASEMENT WINDOW SECTIONS (gs)				
4361	59.00	33.00	2.00	0.888
4274	59.00	33.00	2.50	1.061

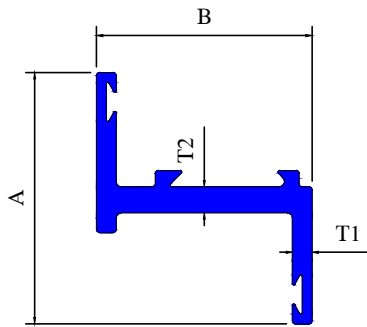

Section	A	B	T1	T2	Wt/Mtr
No	(mm)	(mm)	(mm)	(mm)	(Kgs)
4359	38.50	33.00	2.30	2.30	0.437
4272	38.50	33.00	3.00	4.00	0.662

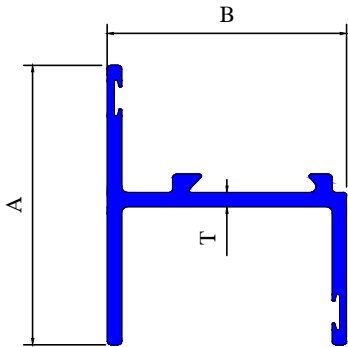

Section	A	B	T	Wt/Mtr
No	(mm)	(mm)	(mm)	(Kgs)
4360	38.50	33.00	2.00	0.494
4273	38.50	33.00	3.00	0.718



CASEMENT WINDOW SECTIONS

Section No 4275

Wt/Mtr 0.753 Kg

Section No 4276

Wt/Mtr 0.656 Kg

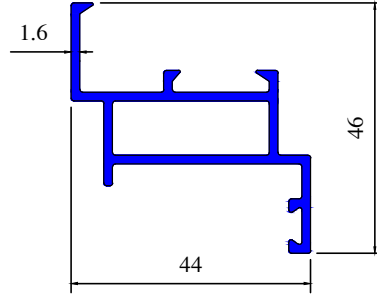
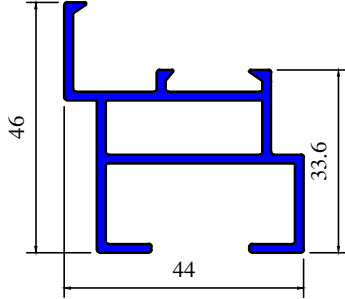

Section No 4277

Wt/Mtr 0.815 Kg

Section No 4278

Wt/Mtr 0.197 Kg

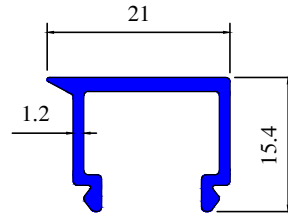
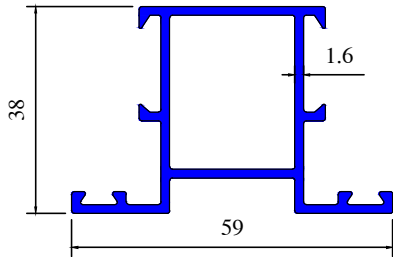

Section No 4387

Wt/Mtr 0.186 Kg

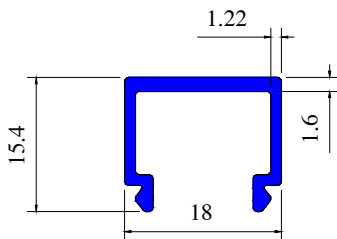



CASEMENT WINDOW SECTIONS

Section No 4289

Wt/Mtr 0.678 Kg

Section No 4290

Wt/Mtr 0.537 Kg

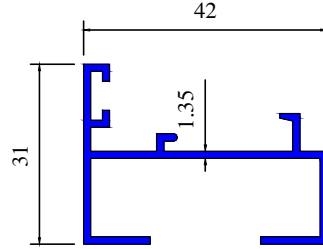
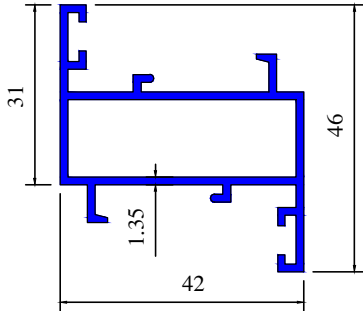

Section No 4291

Wt/Mtr 0.648 Kg

Section No 4292

Wt/Mtr 0.200 Kg

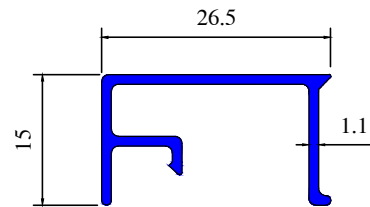
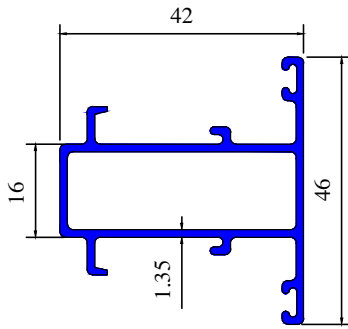

Section No 4545

Wt/Mtr 0.289 Kg

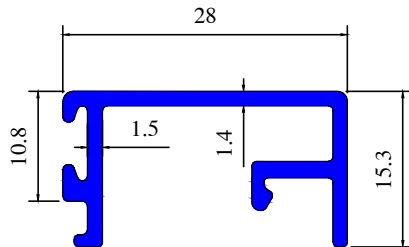



CASEMENT WINDOW SECTIONS

Section No 4298

Wt/Mtr 2.813 Kg

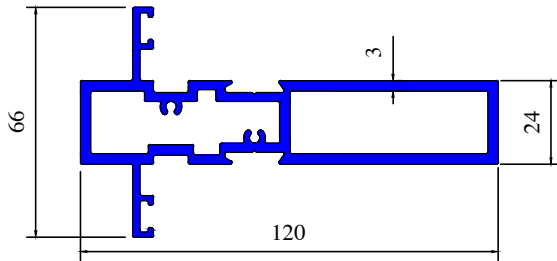

Section No 4319

Wt/Mtr 1.134 Kg

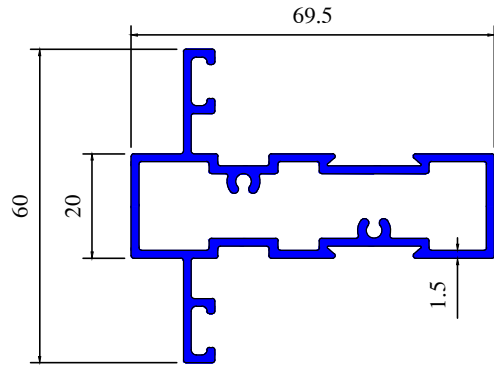

Section No 4302

Wt/Mtr 0.902 Kg

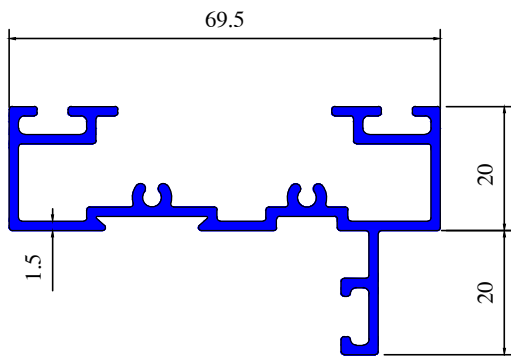

Section No 4299

Wt/Mtr 0.116 Kg

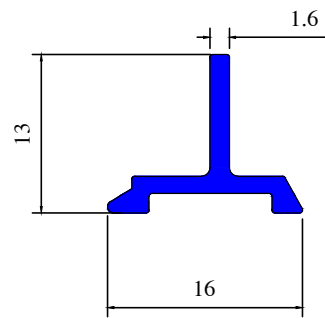

Section No 4317

Wt/Mtr 0.834 Kg

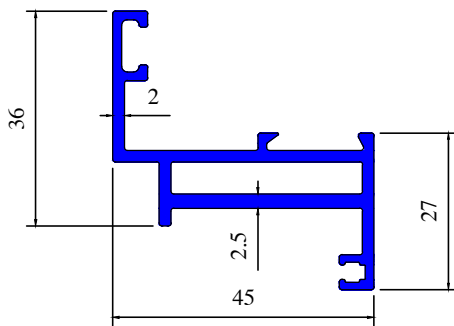

Section No 4318

Wt/Mtr 0.224 Kg

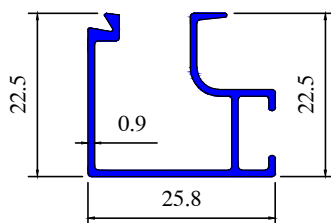

Section No 4383

Wt/Mtr 0.356 Kg

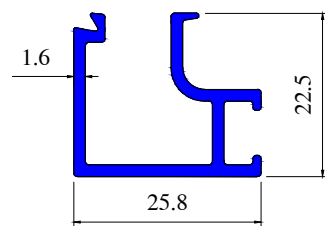



CASEMENT WINDOW SECTIONS

Section No 4346

Wt/Mtr 0.613 Kg

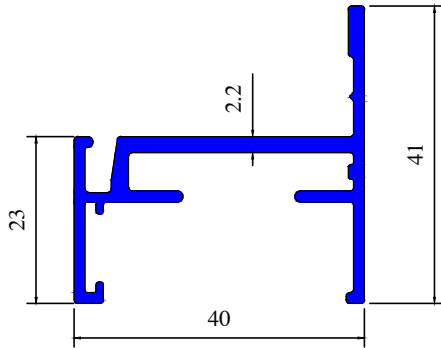

Section No 4345

Wt/Mtr 0.777 Kg

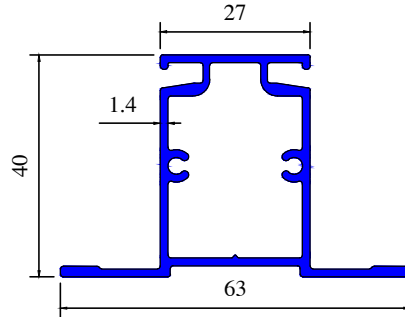

Section No 4347

Wt/Mtr 0.610 Kg

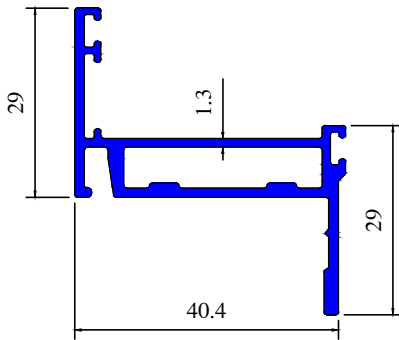

Section No 4348

Wt/Mtr 0.164 Kg

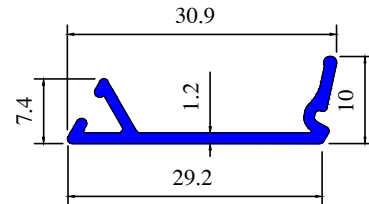

Section No 4022

Wt/Mtr 0.912 Kg

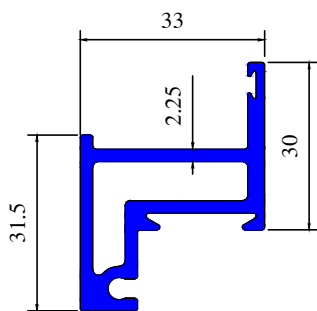

Section No 4425

Wt/Mtr 1.00 Kg

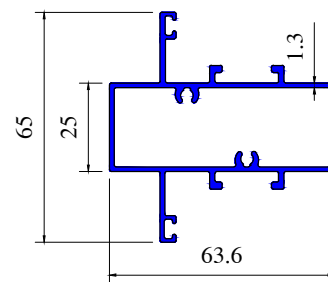



CASEMENT WINDOW SECTIONS

Section No 4534

Wt/Mtr 1.105 Kg

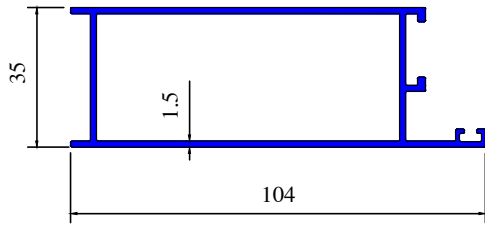

Section No 4535

Wt/Mtr 1.142 Kg

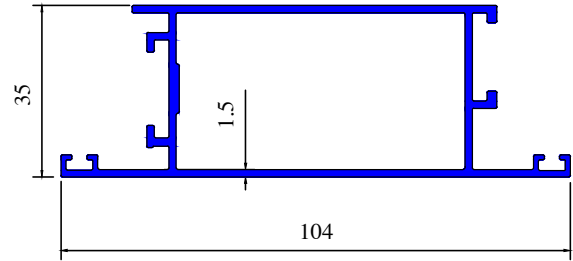

Section No 4536

Wt/Mtr 0.675 Kg

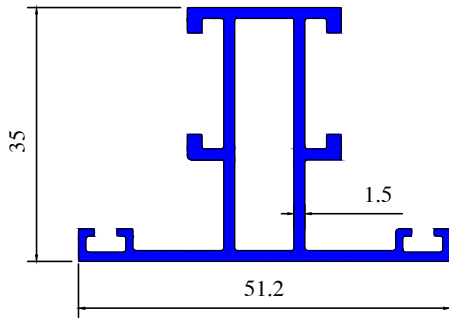

Section No 4533

Wt/Mtr 0.195 Kg

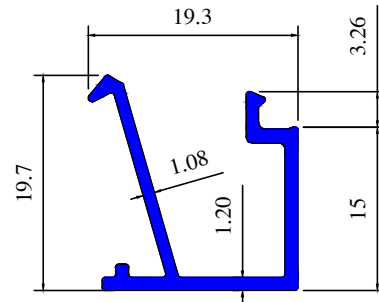

Section No 1587

Wt/Mtr 1.604 Kg

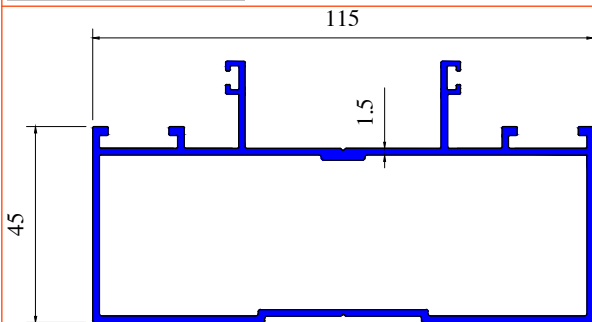

Section No 1173

Wt/Mtr 1.639 Kg

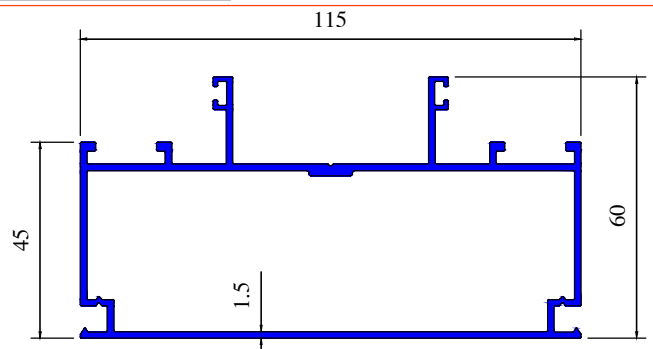

Section No 1195

Wt/Mtr 1.255 Kg

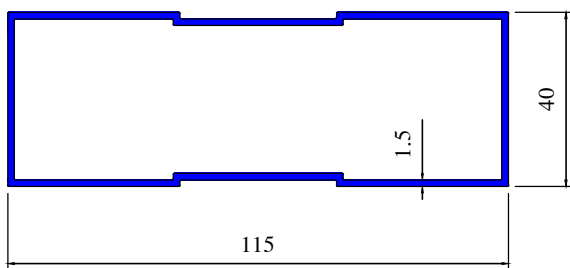

Section No 1174

Wt/Mtr 1.323 Kg

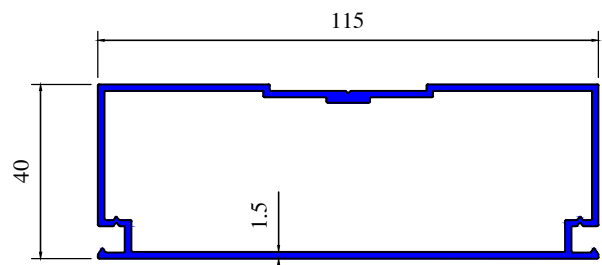



PADMAWATI EXTRUSION PVT. LTD.

5/2, Bharat Ashish Building, D.B. Gupta Road, Paharganj, New Delhi - 110055 (India)
+91 98999 07895, 98112 76191 | Email : info@padmawatiextrusion.com