



PADMAWATI
EXTRUSION

CATALOGUE 2019

90 SERIES

Padmawati Extrusion Pvt. Ltd., with over 2 decades of experience, with focus on customer need and commitment to **quality, perfection and innovation**, has become one of the leading nationwide providers of aluminium.

The company has been engaged in the complete process of extrusion, from technical sales advise, designing, testing to providing all ancillary, hardware fittings for system windows, glazing systems, exhibition systems and various products and caters to architects, contractors and designers from different sectors & industries.

With an eye on quality, the company has also introduced **aluminium profiles with scratch free sand blasted anodize finish, brush anodize finish, mirror finish and various powder coated finishes** for our discerning customers.

Our way of working reflects delivering an advantage in every key aspect of our business – sourcing, operations and cost. Basically, we are a **one stop shop for extruded aluminium** custom solutions for practically any application.





90 Series

Section No. 9001

Wt/Mtr 1.596 kg

P60338

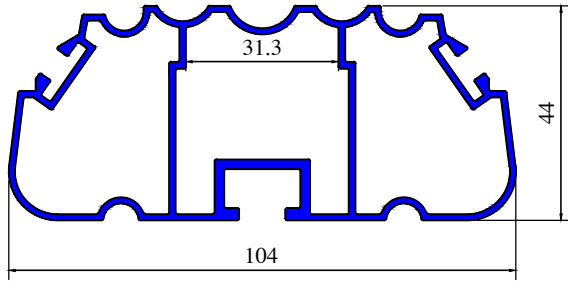

Section No. 9005

Wt/Mtr 1.177 kg

P60309

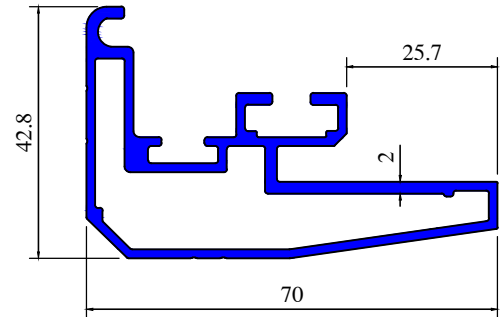

Section No. 9002

Wt/Mtr 0.672 kg

P60341

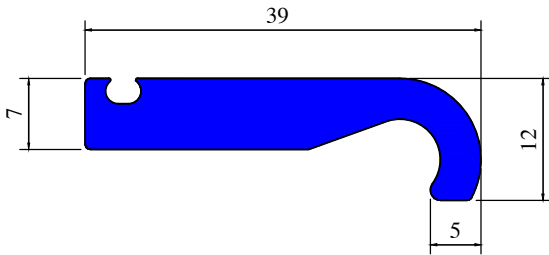

Section No. 9006

Wt/Mtr 2.658 kg

P60308

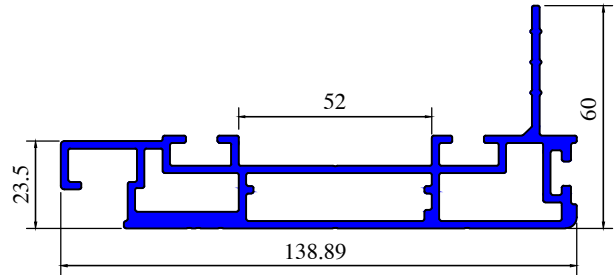

Section No. 9003

Wt/Mtr 1.084 kg

P60340

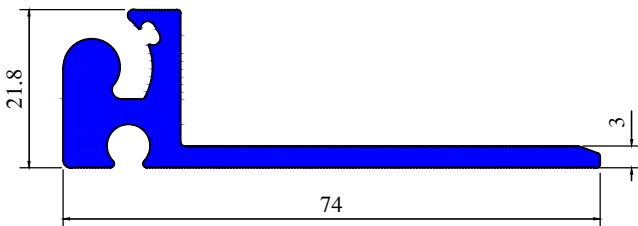

Section No. 9007

Wt/Mtr 0.154 kg

P60329

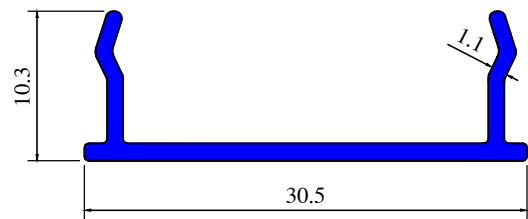

Section No. 9004

Wt/Mtr 1.135 kg

P60342

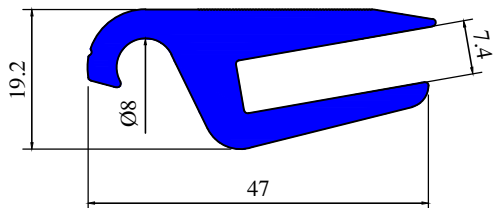

Section No. 9008

Wt/Mtr 0.885 kg

P60328

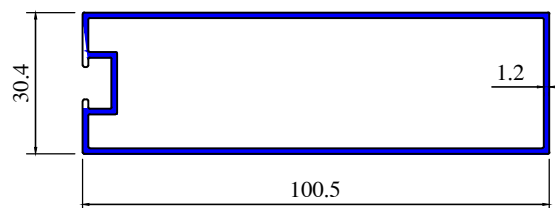



90 Series

Section No. 9009

Wt/Mtr 2.617 kg

P60348

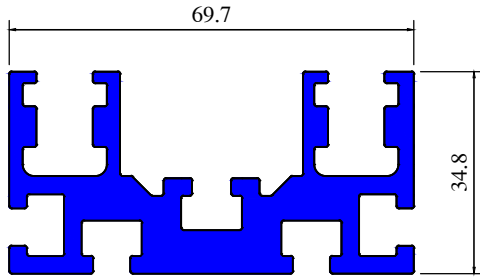

Section No. 9013

Wt/Mtr 6.127 kg

P60291

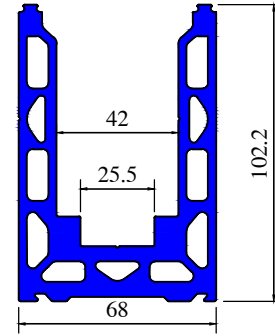

Section No. 9010

Wt/Mtr 0.793 kg

P60256

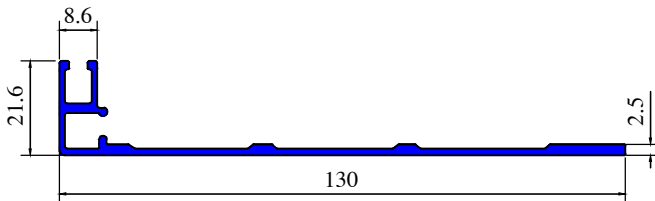

Section No. 9014

Wt/Mtr 0.175 kg

P60290

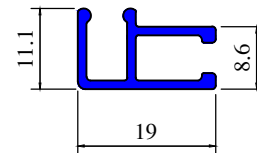

Section No. 9011

Wt/Mtr 0.714 kg

19499

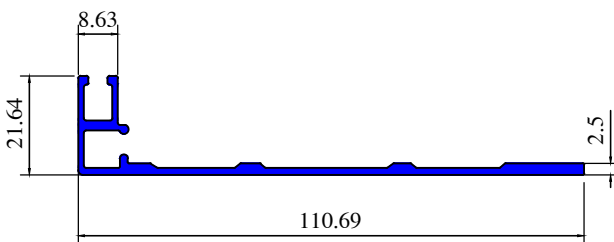

Section No. 9015

Wt/Mtr 0.812 kg

P60346

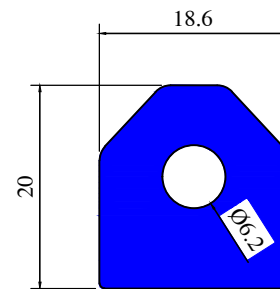

Section No. 9012

Wt/Mtr 6.413 kg

P60255

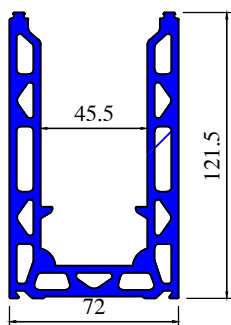

Section No. 9016

Wt/Mtr 0.602 kg

P50064

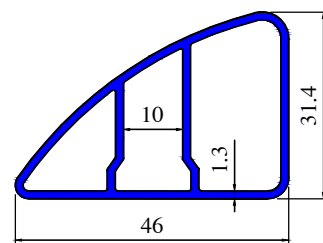

PADMAWATI EXTRUSION PVT. LTD.

REG. OFF: 5/2, BHARAT ASHISH BUILDING D.B GUPTA ROAD, PAHARGANG, DELHI-110055
PH: 011-23219291, 23239291 E-mail: info@padmawatiextrusion.com URL: padmawatiextrusion.com



90 Series

Section No. 9017

Wt/Mtr 1.262 kg

P60355

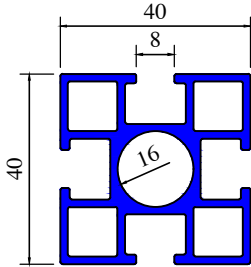

Section No. 9021

Wt/Mtr 0.324 kg

P60333

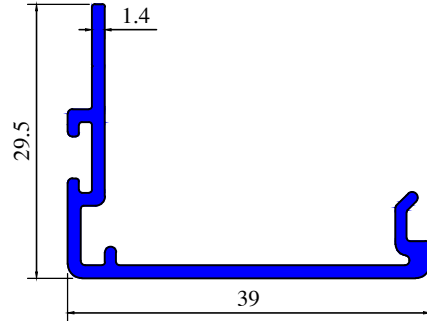

Section No. 9018

Wt/Mtr 4.045 kg

P60344

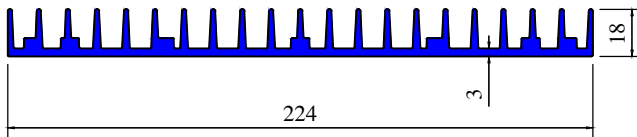

Section No. 9022

Wt/Mtr 0.602 kg

P60330

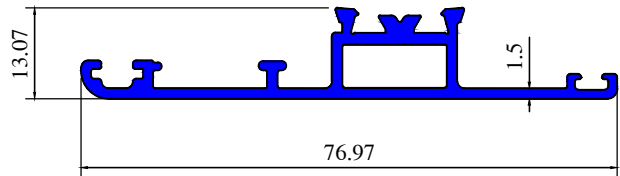

Section No. 9019

Wt/Mtr 0.266 kg

P60334

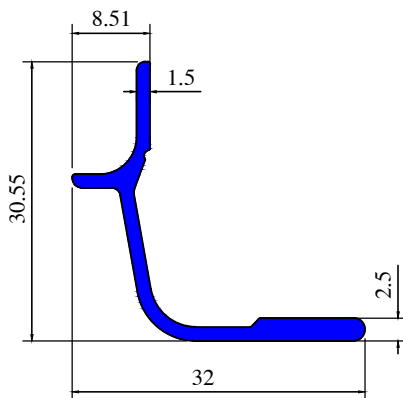

Section No. 9023

Wt/Mtr 0.884 kg

P60331

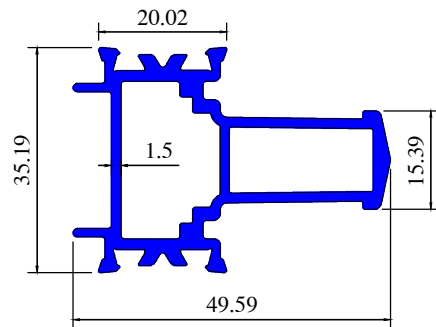

Section No. 9020

Wt/Mtr 1.310 kg

P60356

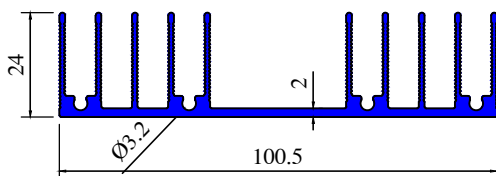

Section No. 9024

Wt/Mtr 0.757 kg

P60332

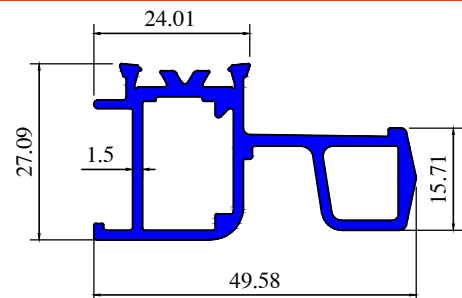

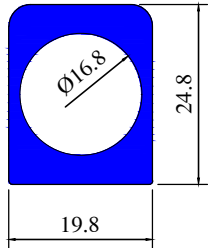
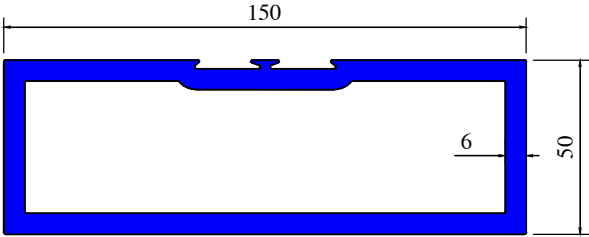
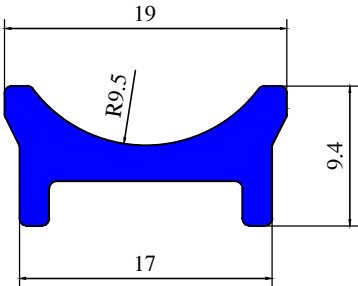
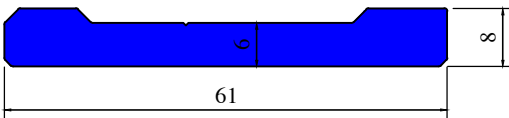
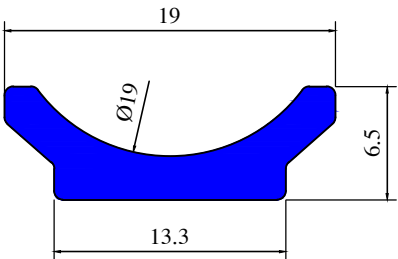
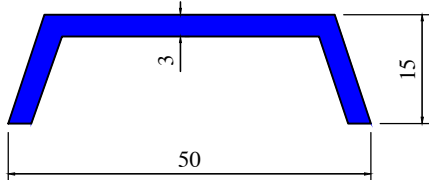
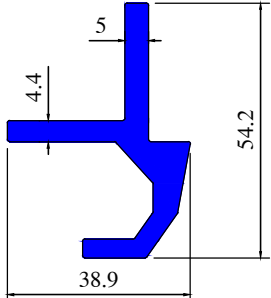
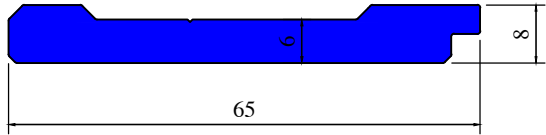

90 Series

Section No. 9025	Wt/Mtr 0.716 kg	Section No. 9029	Wt/Mtr 6.177 kg
P50099		P60419	
Section No. 9026	Wt/Mtr 0.226 kg	Section No. 9030	Wt/Mtr 1.092 kg
P60429		VEW/P002	
Section No. 9027	Wt/Mtr 0.165 kg	Section No. 9031	Wt/Mtr 0.540 kg
P60430		VEW/P004	
Section No. 9028	Wt/Mtr 1.308 kg	Section No. 9032	Wt/Mtr 1.147 kg
P60357		VEW/P001	



90 Series

Section No. 9033

Wt/Mtr 5.926 kg

P60388

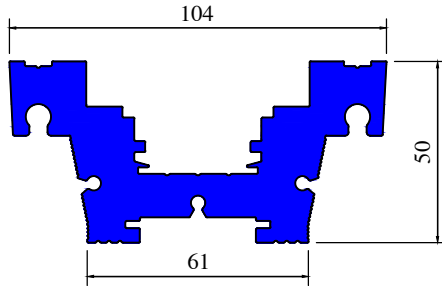

Section No. 9037

Wt/Mtr 0.738 kg

P60107

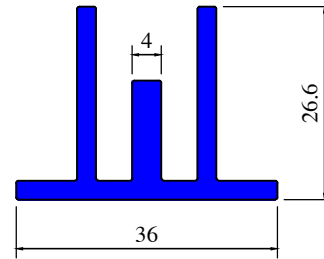

Section No. 9034

Wt/Mtr 3.831 kg

VEW/P007
P60500

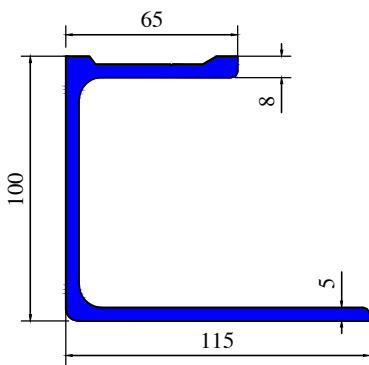

Section No. 9038

Wt/Mtr 3.800 kg

P60459

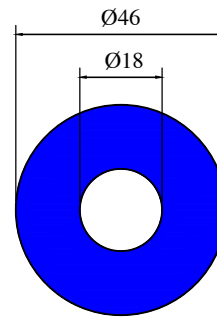

Section No. 9035

Wt/Mtr 3.100 kg

VEW/P006
P60499

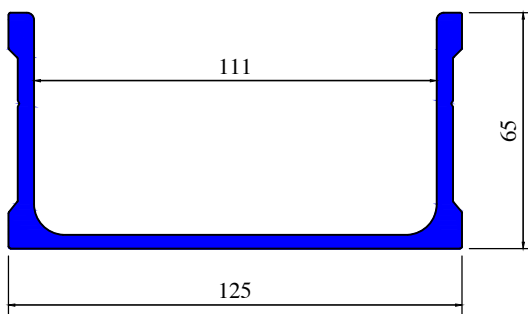

Section No. 9039

Wt/Mtr 1.199 kg

P60456

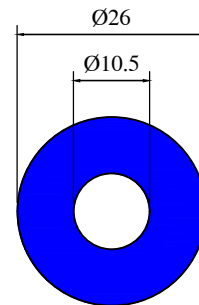

Section No. 9036

Wt/Mtr 2.833 kg

VEW/P005
P60498

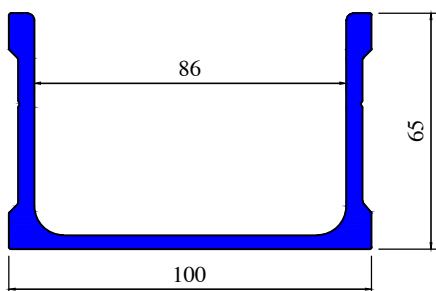

Section No. 9040

Wt/Mtr 0.485 kg

P60455

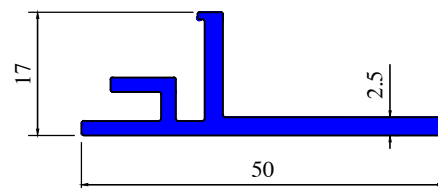



90 Series

Section No. 9041

Wt/Mtr 2.606 kg

P50061

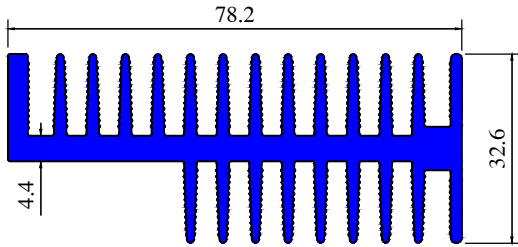

Section No. 9045

Wt/Mtr 0.829 kg

P60293

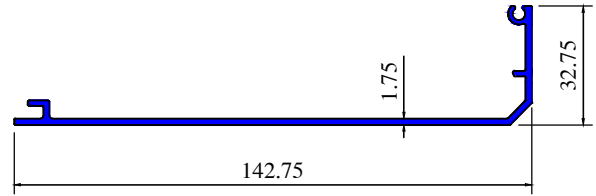

Section No. 9042

Wt/Mtr 0.966 kg

VEW/P003

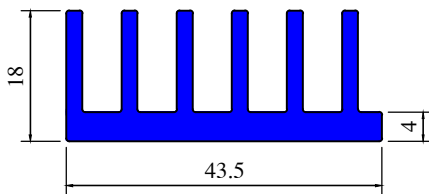

Section No. 9046

Wt/Mtr 0.168 kg

P60467

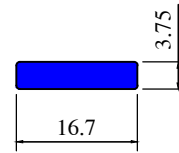

Section No. 9043

Wt/Mtr 14.787 kg

P60411

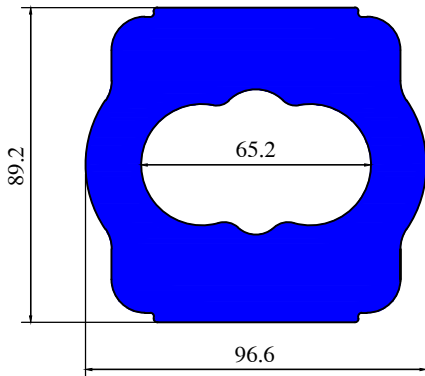

Section No. 9047

Wt/Mtr 0.410 kg

P60460

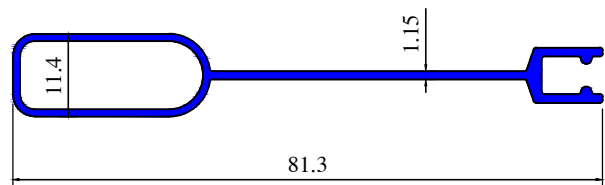

Section No. 9044

Wt/Mtr 2.129 kg

P60126

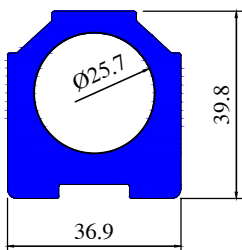

Section No. 9048

Wt/Mtr 0.980 kg

P60305

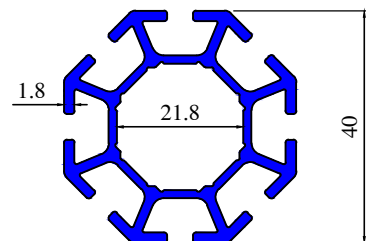



90 Series

Section No. 9049

Wt/Mtr 0.931 kg

P60503

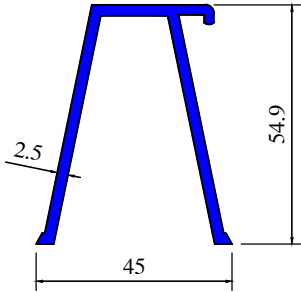

Section No. 9053

Wt/Mtr 3.566 kg

P60504

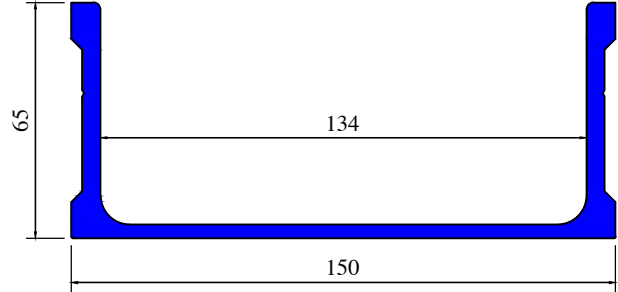

Section No. 9050

Wt/Mtr 0.870 kg

P60502

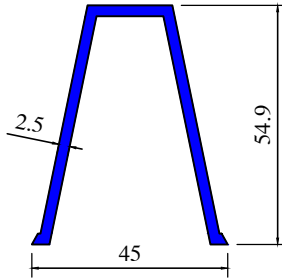

Section No. 9054

Wt/Mtr 0.994 kg

P60463

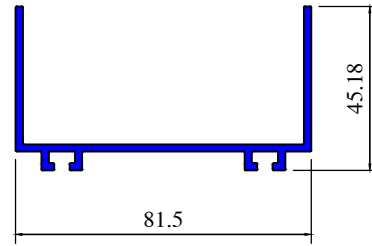

Section No. 9051

Wt/Mtr 1.548 kg

P60458

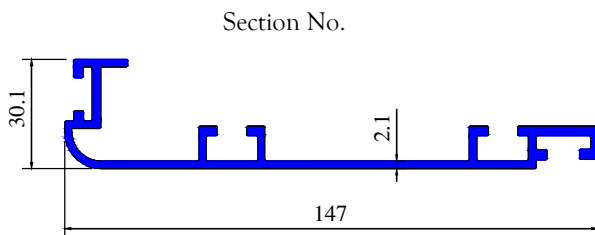

Section No. 9055

Wt/Mtr 0.301 kg

P60466

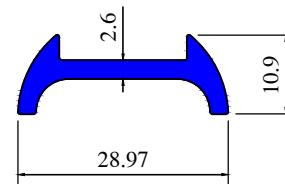

Section No. 9052

Wt/Mtr 2.832 kg

P60501

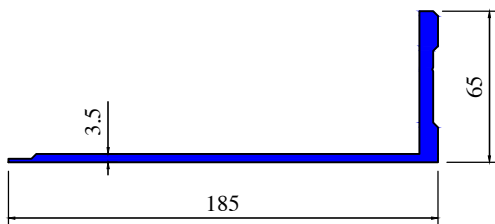

Section No. 9056

Wt/Mtr 0.665 kg

P60471

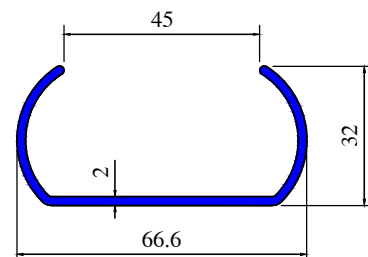



90 Series

Section No. 9057

Wt/Mtr 0.802 kg

P60472

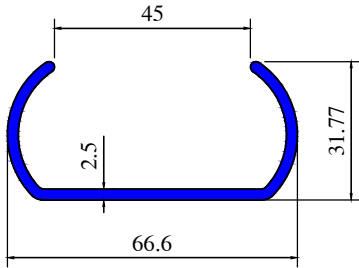

Section No. 9061

Wt/Mtr 0.496 kg

P60472

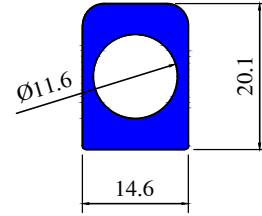

Section No. 9058

Wt/Mtr 0.998 kg

P60473

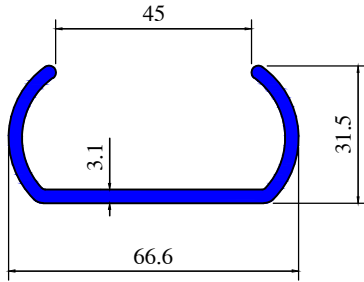

Section No. 9062

Wt/Mtr 0.218 kg

P60476

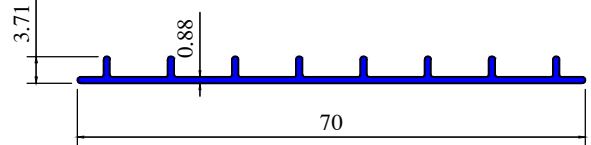

Section No. 9059

Wt/Mtr 0.895 kg

P60475

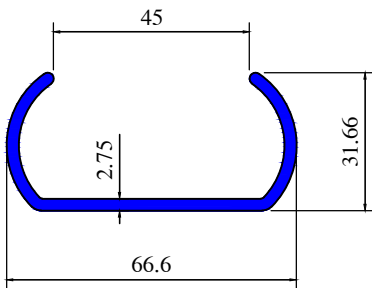

Section No. 9063

Wt/Mtr 0.346 kg

VEW/P012
P60548

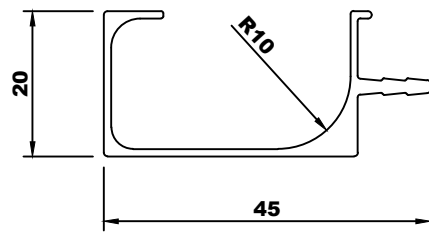

Section No. 9060

Wt/Mtr 0.794 kg

P60402

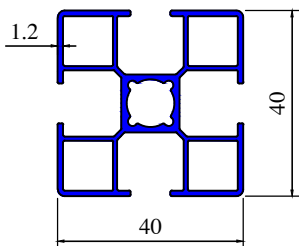

Section No. 9064

Wt/Mtr 0.534 kg

P60426

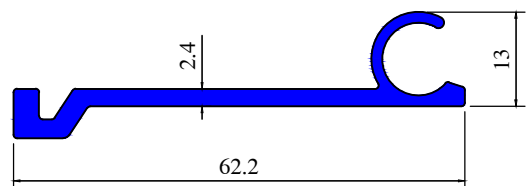



90 Series

Section No. 9065 Wt/Mtr 16.257 kg Section No. 9069 Wt/Mtr 0.116 kg

P60412

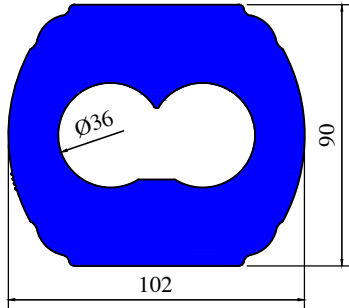

P60461

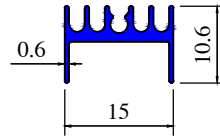

Section No. 9066 Wt/Mtr 5.577 kg Section No. 9070 Wt/Mtr 0.139 kg

P60351

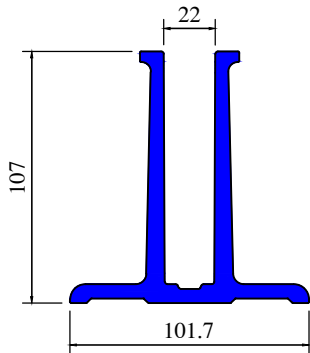

P60461

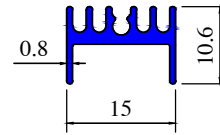

Section No. 9067 Wt/Mtr 8.228 kg Section No. 9071 Wt/Mtr 1.343 kg

P60292

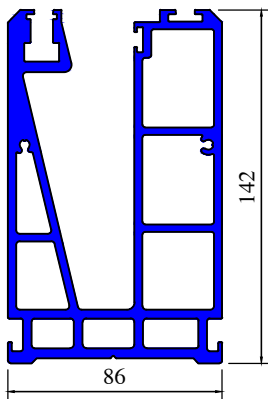

P60457

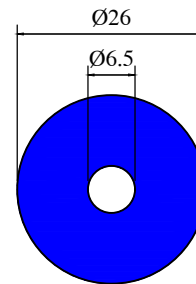

Section No. 9068 Wt/Mtr 2.264 kg Section No. 9072 Wt/Mtr 3.224 kg

16727

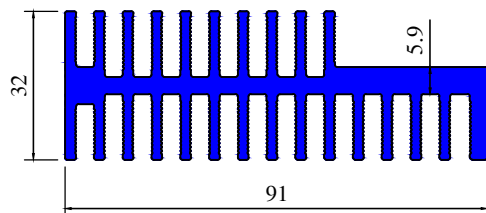
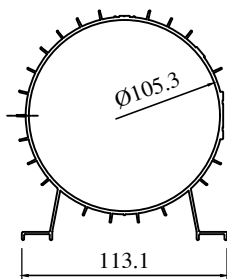



90 Series

Section No. 9073 Wt/Mtr 3.132 kg Section No. 9077 Wt/Mtr 0.148 kg

P60137

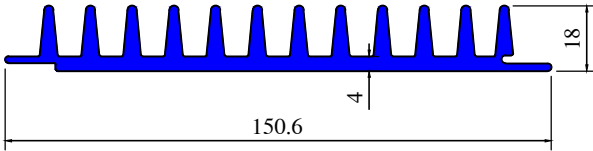

P60488

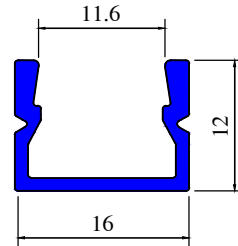

Section No. 9074 Wt/Mtr 2.357 kg Section No. 9078 Wt/Mtr 0.345 kg

P60483

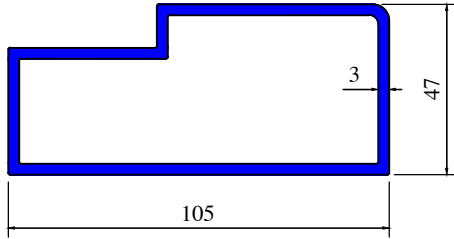

P60489

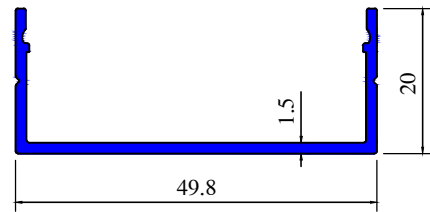

Section No. 9075 Wt/Mtr 1.488 kg Section No. 9079 Wt/Mtr 0.284 kg

P60477

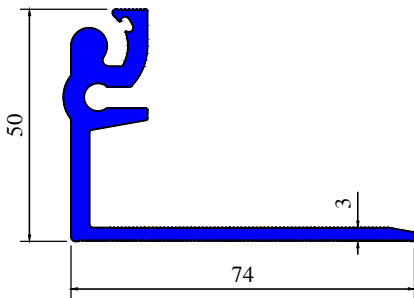

P60490

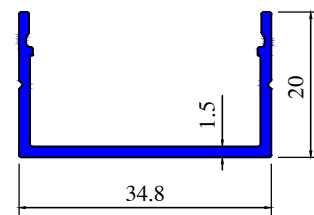

Section No. 9076 Wt/Mtr 0.162 kg Section No. 9080 Wt/Mtr 0.533 kg

P60487

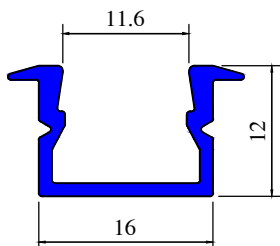

P60491

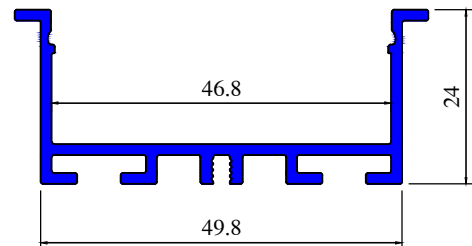



90 Series

Section No. 9081 Wt/Mtr 0.432 kg Section No. 9085 Wt/Mtr 0.391 kg

P60492

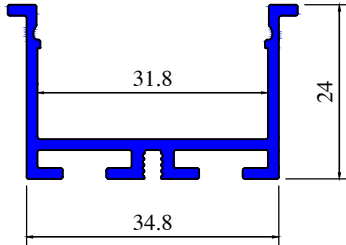

P60481

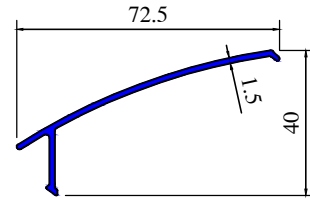

Section No. 9082 Wt/Mtr 0.074 kg Section No. 9086 Wt/Mtr 2.354 kg

P60486

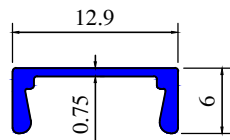

P60479

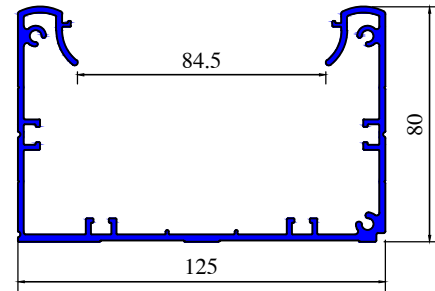

Section No. 9083 Wt/Mtr 0.084 kg Section No. 9087 Wt/Mtr 2.312 kg

P60493

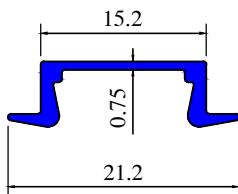

P60480

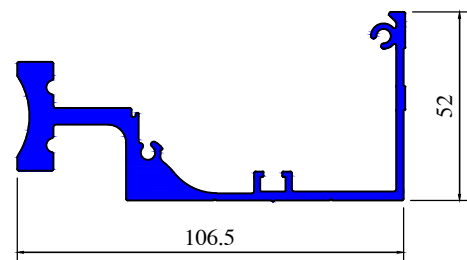

Section No. 9084 Wt/Mtr 0.655 kg Section No. 9088 Wt/Mtr 0.763 kg

P60482

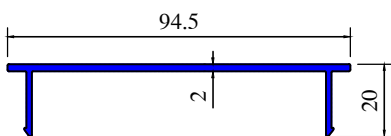

P60547

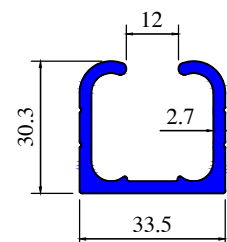

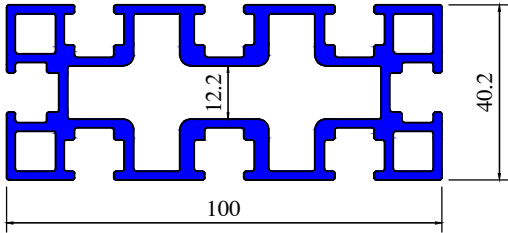
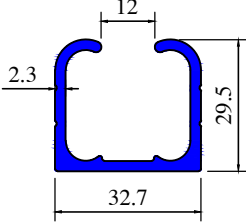
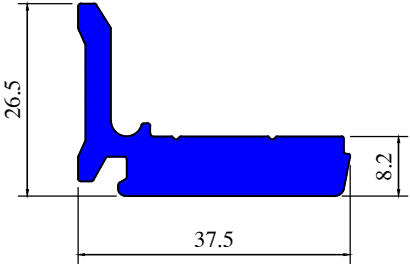
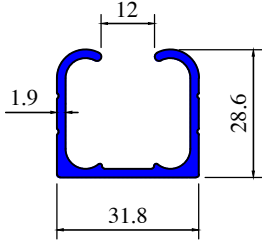
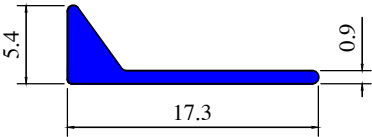
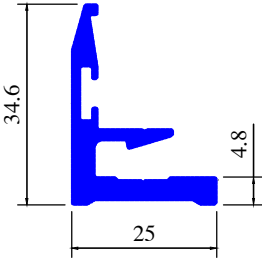
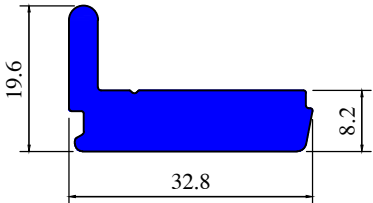
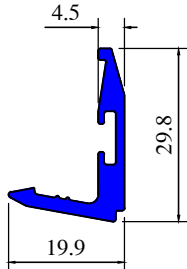

90 Series

Section No. 9089	Wt/Mtr 3.089 kg	Section No. 9093	Wt/Mtr 0.649kg
15502 		P60546 	
Section No. 9090	Wt/Mtr 0.931 kg	Section No. 9094	Wt/Mtr 0.524 kg
P50053 		P60545 	
Section No. 9091	Wt/Mtr 0.068 kg	Section No. 9095	Wt/Mtr 0.600 kg
P60512 		P60011 	
Section No. 9092	Wt/Mtr 0.803 kg	Section No. 9096	Wt/Mtr 0.348 kg
P50052 		P60012 	



90 Series

Section No. 9097

Wt/Mtr 0.531 kg

Section No. 9102

Wt/Mtr 1.392 kg

P60542

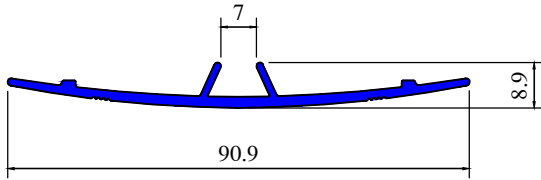

P60401

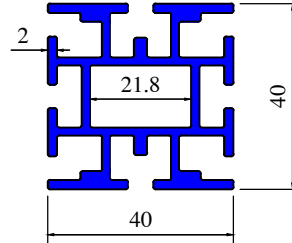

Section No. 9098

Wt/Mtr 0.276 kg

Section No. 9103

Wt/Mtr 0.992 kg

P60510

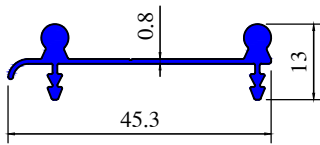

P60573

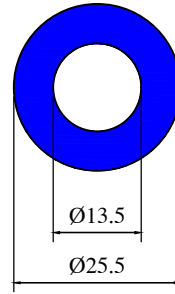

Section No. 9099

Wt/Mtr 0.586 kg

Section No. 9104

Wt/Mtr 1.290 kg

P60560

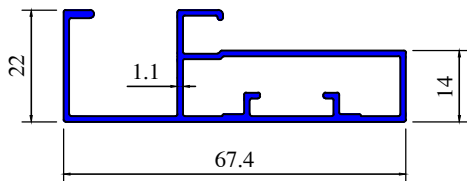

P60508

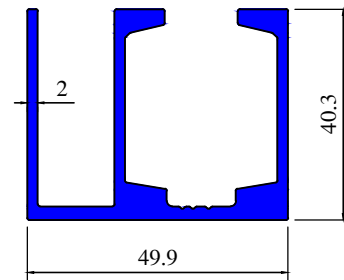

Section No. 9101

Wt/Mtr 0.436 kg

Section No. 9105

Wt/Mtr 1.051 kg

P60561

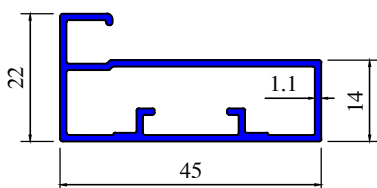

P60587

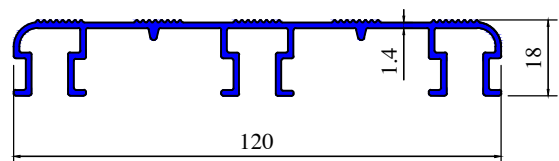



90 Series

Section No. 9106

Wt/Mtr 0.194 kg

Section No. 9110

Wt/Mtr 0.279 kg

P60511

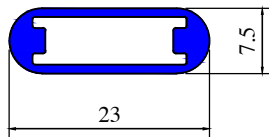

P60563

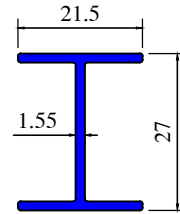

Section No. 9107

Wt/Mtr 0.106 kg

Section No. 9111

Wt/Mtr 2.066 kg

P60009

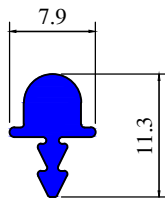

P60556

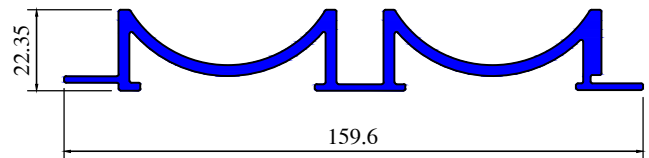

Section No. 9108

Wt/Mtr 0.347 kg

Section No. 9112

Wt/Mtr 1.257 kg

P60541

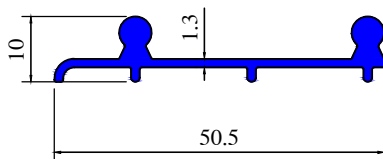

P60521

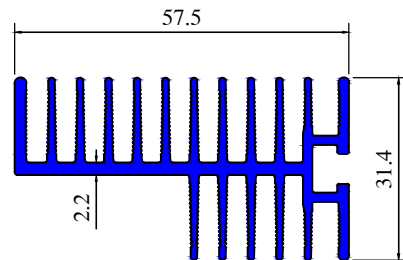

Section No. 9109

Wt/Mtr 1.386 kg

Section No. 9113

Wt/Mtr 1.705 kg

P60485

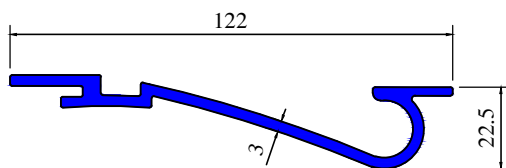

P60572

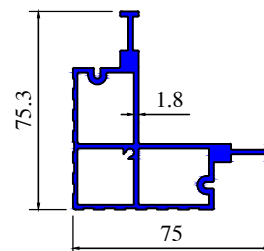



90 Series

Section No. 9114

Wt/Mtr 0.715 kg

P60568

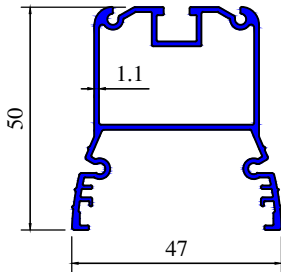

Section No. 9118

Wt/Mtr 1.423 kg

P60562

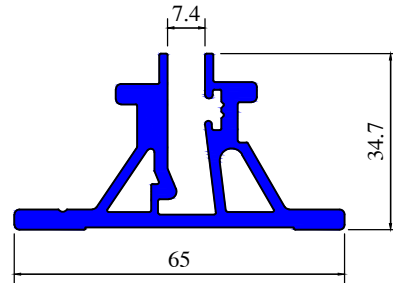

Section No. 9115

Wt/Mtr 0.359 kg

P60509

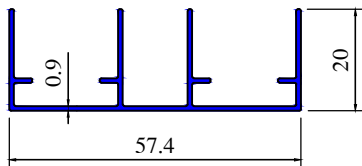

Section No. 9119

Wt/Mtr 0.327 kg

P60595

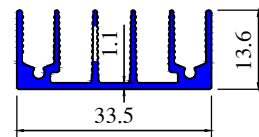

Section No. 9116

Wt/Mtr 1.109 kg

P60517

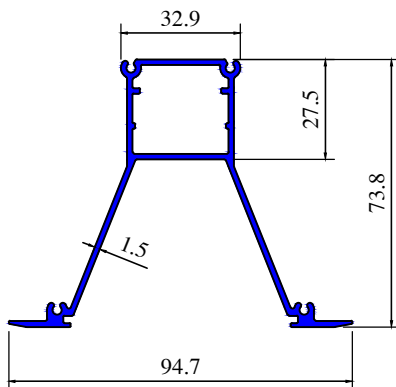

Section No. 9120

Wt/Mtr 2.913 kg

P60596

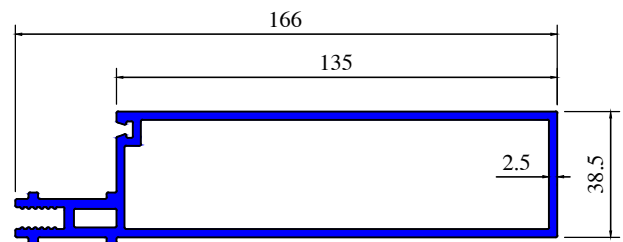

Section No. 9117

Wt/Mtr 0.449 kg

P60540

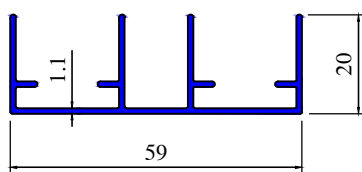

Section No. 9121

Wt/Mtr 3.094 kg

P60597

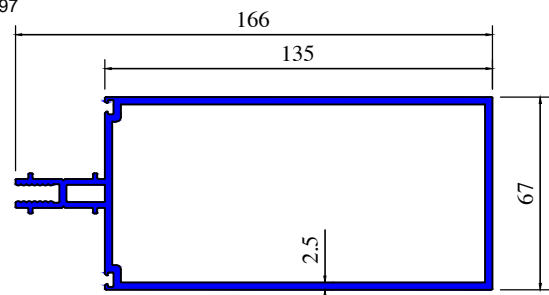

PADMAWATI EXTRUSION PVT. LTD.

REG. OFF: 5/2, BHARAT ASHISH BUILDING D.B GUPTA ROAD, PAHARGANG, DELHI-110055
PH: 011-23219291, 23239291 E-mail: info@padmawatiextrusion.com URL: padmawatiextrusion.com



90 Series

Section No. 9130 Wt/Mtr 0.337 kg Section No. 9134 Wt/Mtr 1.374 kg

P60558

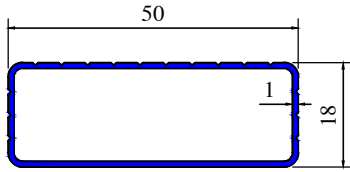

P60593

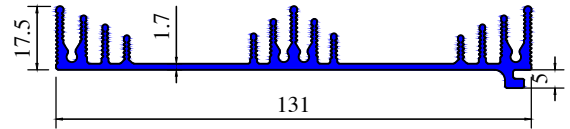

Section No. 9131 Wt/Mtr 0.527 kg Section No. 9135 Wt/Mtr 4.132 kg

P60607

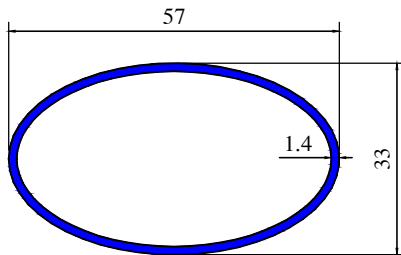

P60583

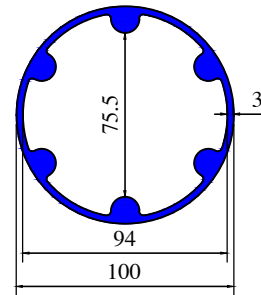

Section No. 9132 Wt/Mtr 2.711 kg Section No. 9136 Wt/Mtr 15.770 kg

P60588

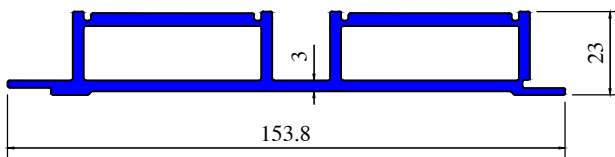

P60594

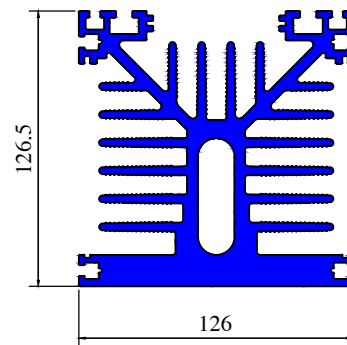

Section No. 9133 Wt/Mtr 8.139 kg Section No. 9137 Wt/Mtr 1.717 kg

P60574

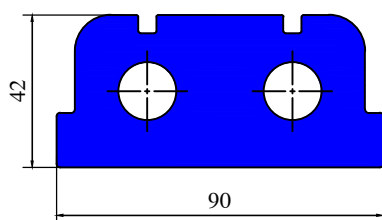

P60565

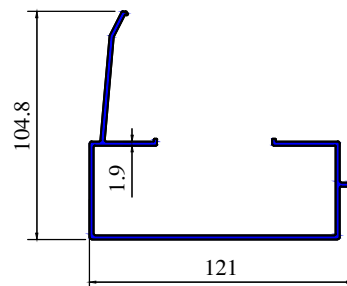



90 Series

Section No. 9138

Wt/Mtr 1.638 kg

Section No. 9142

Wt/Mtr 15.109 kg

P60566

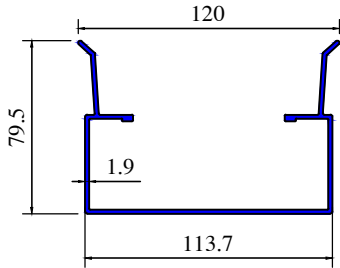

P60610

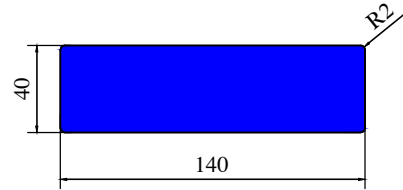

Section No. 9139

Wt/Mtr 0.475 kg

Section No. 9143

Wt/Mtr 5.937 kg

P60567

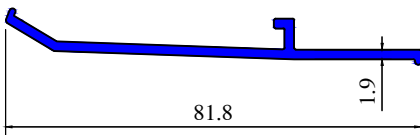

P60613

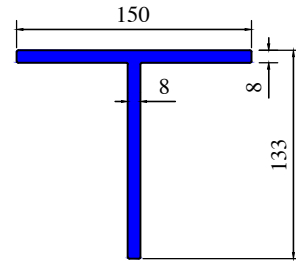

Section No. 9140

Wt/Mtr 1.722 kg

Section No. 9144

Wt/Mtr 4.317 kg

P60612

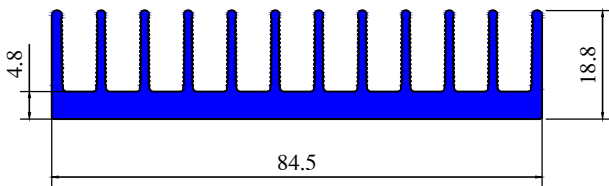

P60614

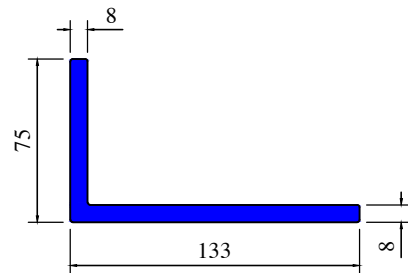

Section No. 9141

Wt/Mtr 18.214 kg

Section No. 9145

Wt/Mtr 2.006 kg

P60609

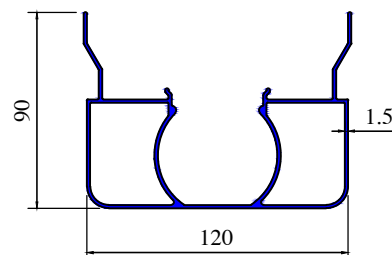
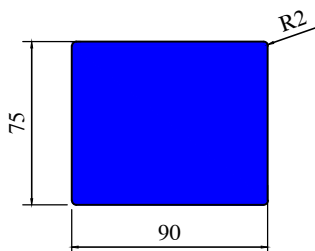



90 Series

Section No. 9146

Wt/Mtr 4.009 kg

P60566

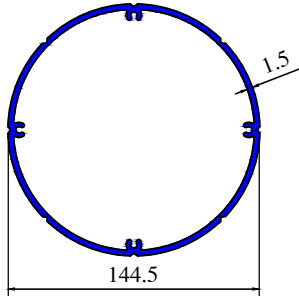

Section No. 9147

Wt/Mtr 2.144kg

P60615

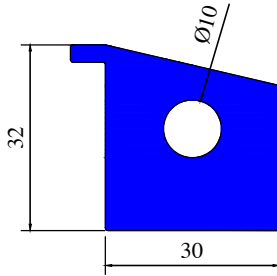

Section No. 9148

Wt/Mtr 2.062kg

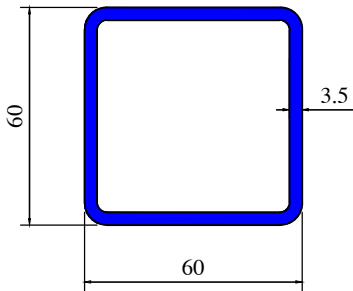



PADMAWATI EXTRUSION PVT. LTD.

5/2, Bharat Ashish Building, D.B. Gupta Road, Paharganj, New Delhi - 110055 (India)
+91 98999 07895, 98112 76191 | Email : info@padmawatiextrusion.com